

30V, 1.5A 1.2MHZ Synchronous Buck Converter

FEATURES

- Up to 95% Efficiency
- Input Voltage Range: 4.5V to 30V
- Continuous Output Current: 1.5A
- CCM Switching Frequency: 1.2MHz
- Reference Voltage: 0.8V \pm 2% @25°C
- Maximum Duty Cycle: 98%
- Integrated MOSFETs: 200m Ω and 120m Ω
- Low Quiescent Current: 500 μ A
- Low Shutdown Current: 3 μ A
- COT Control
- Optional Operation Modes at FCCM
- Over Current Protection
- Short Protection with Hiccup-Mode
- Internal Soft Startup
- Thermal Shutdown Protection

DESCRIPTIONS

The DP31231F is a low EMI signature, synchronous, step-down, COT-mode converter with internal power MOSFETs. It offers a very compact solution to provide 1.5A continuous current over a wide input supply range, with excellent load and line regulation. DP31231F achieves low EMI signature with well controlled switching edges. Fault condition protection includes programmable - output over-voltage protection, and thermal shutdown. package.

FCCM mode operation provides very low output ripple voltage for noise sensitive applications. Switching frequency is internally set at 1.2MHz, allowing the use of small surface mount inductors and capacitors. Low output voltages are easily supported with the 0.8V feedback reference voltage.

The DP31231F requires a minimal number of readily available, external components and is available in a small package.

APPLICATIONS

- Automotive Entertainment
- Wireless and DSL Modems
- Computer Entertainment
- IoT Applications
- Digital Still and Video Cameras
- Portable Instruments

ORDERING INFORMATION

Part Number	Description
SOT23-6	Pb free in T&R, 3000 Pcs/Reel

TYPICAL APPLICATION CIRCUIT

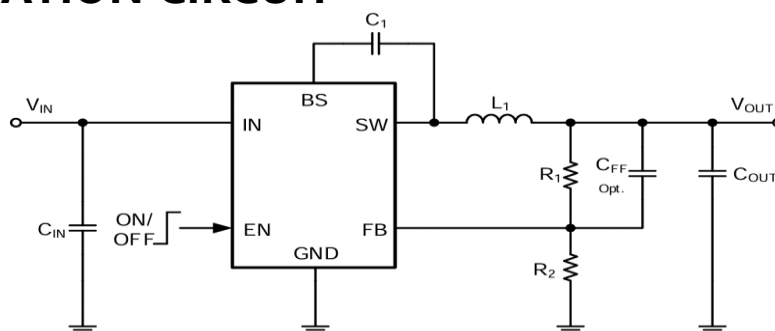



PRODUCT DESCRIPTION

➤ Pin Arrangement

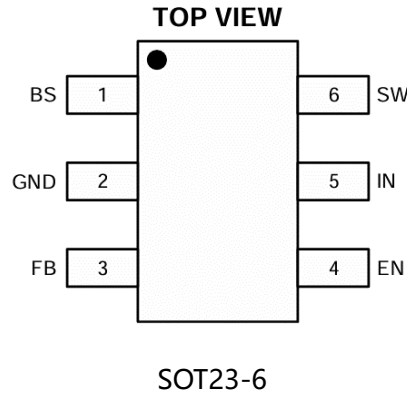

➤ Pin Configuration

SOT23-6	Pin Name	Description
1	BS	Supply input for the high-side NFET gate drive circuit. Connect a 0.1 μ F capacitor between VBST and SW pins.
2	GND	Ground Pin
3	FB	Feedback pin for the internal control loop. Connect this pin to an external feedback divider.
4	EN	Chip Enable Pin. Drive EN above 1.5V to turn on the part. Drive EN below 0.4V to turn it off.
5	IN	Power supply voltage input.
6	SW	Switch pin connected to the internal FET switches and inductor terminal. Connect the inductor of the output filter to this pin.



➤ Marking Information



DP31231 for product name:

YYY refers to the following table description, represents different packaging and special functions

XXXX The first X represents the last year,2020 is 0;The second X represents the month,inA-L 12 letters;The third and fourth X on behalf of the date,01-31said;

Marking	Model	Description
31231F	DP31231FAST	DP31231FAST Buck, 4.0V~30V, 1.5A, 1.2MHZ, VFB 0.8V, FCCM , SOT23-6



➤ Absolute Maximum Ratings

PARAMETER	Min	Max	Unit
VIN Voltage	-0.3	33	V
EN Voltage	-0.3	33	V
SW Voltage(DC)	-0.3	34	V
SW Voltage(AC less than 10ns while Switching)	-5	36	V
FB Voltage	-0.3	6.5	V
BS Voltage(vs SW)	-0.3	5	V
Operating junction temperature,TJ	-40	150	°C
Storage temperature, Tstg	-65	150	°C
Lead Temperature (Soldering, 10sec.)	-	260	°C

Over operating temperature range (unless otherwise noted)(1)

Note:(1)Stresses beyond those listed under absolute maximum ratings may cause permanent damage to the device. Functional operation of the device at these or any other conditions beyond those indicated under recommended operating conditions is not implied. Exposure to absolute–maximum–rated conditions for extended periods may affect device reliability.

(2) All voltage values are with respect to network ground terminal

➤ Recommended Operating Conditions

PARAMETER	Min	Max	Unit
VIN Voltage(VIN)	4.5	30	V
Output current(IOUT)	0	1.5	A
TJ	-40	125	°C

Note : (1)All limits specified at room temperature (TA = 25°C) unless otherwise specified. All room temperature limits are 100% production tested. All limits at temperature extremes are ensured through correlation using standard Statistical Quality Control (SQC) methods. All limits are used to calculate Average Outgoing Quality Level (AOQL).



➤ ESD Ratings

PARAMETER	Description	Value	Unit
HBM	Human-body model (HBM), per ANSI/ESDA/JEDEC JS-001(1)	±2000	V
CDM	Charged-device model (CDM), per JEDEC specification JESD22-C101(2)	±200	V

Note : (1) JEDEC document JEP155 states that 500-V HBM allows safe manufacturing with a standard ESD control process.

(2) JEDEC document JEP157 states that 250-V CDM allows safe manufacturing with a standard ESD control process.

➤ Thermal Information

THERMAL METRIC	Description	SOT23-6	Unit
$R_{\theta JA}$	Junction-to-ambient thermal resistance(1)(2)	121.6	°C/W
$R_{\theta JC(top)}$	Junction-to-case (top) thermal resistance	69.1	°C/W
$R_{\theta JB}$	Junction-to-board(Bottom) thermal resistance	45.5	°C/W
Ψ_{JT}	Junction-to-top characterization parameter	22.3	°C/W
Ψ_{JB}	Junction-to-board characterization parameter	46	°C/W

Note (1): The package thermal impedance is calculated in accordance to JESD 51-7.

Note (2): Thermal Resistances were simulated on a 4-layer, JEDEC board



BLOCK DIAGRAM

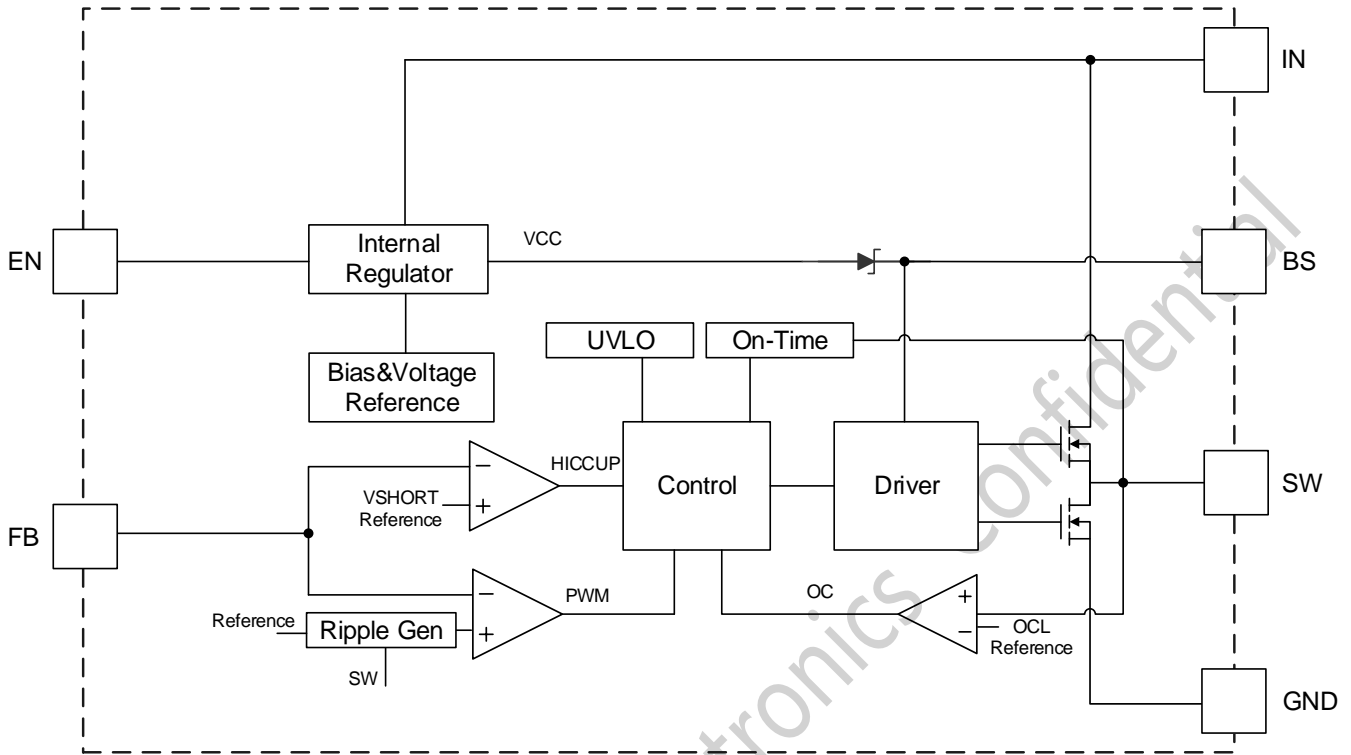



ELECTRICAL CHARACTERISTICS(Typical at $V_{in}=12V, T_J=25^{\circ}C$, unless otherwise noted.)

Parameter	Symbol	Test Conditions	Min	Typ	Max	Units
Input Voltage	V_{IN}		4.5		30	V
V_{IN} Quiescent Current	I_Q	$V_{out}=5V, V_{EN}=12V, I_{out}=0A$		10		mA
Shutdown Current	I_{SHDN}	$V_{EN}=0V$		3		μA
V_{IN} UVLO Rising Threshold	$V_{UVLO(R)}$	V_{IN} Rsing		4.0		V
V_{IN} UVLO Falling Threshold	$V_{UVLO(F)}$	V_{IN} Falling		3.7		V
V_{IN} UVLO Hysteresis	$V_{UVLO(HYS)}$			0.3		V
V_{IN} OVP Rising Threshold	$V_{OVP(R)}$	V_{IN} Rsing		33		V
V_{IN} OVP Hysteresis	$V_{OVP(HYS)}$			1		V
FB Voltage	V_{FB}	$T_J=25^{\circ}C$	0.790	0.8	0.810	V
FB Leakage Current	$I_{FB(LKG)}$	$T_J=25^{\circ}C$	-100	0	100	nA
Switching Frequency	F_{sw}	$V_{OUT}=1.2V$, Operation CCM		1200		KHZ
Max duty cycle	D_{max}				98	%
Mini on Pulse Width	$T_{ON(MIN)}$			90		ns
High-Side Switch Current Limit	$I_{HS(OC)}$	$V_{IN}=12V, V_{FB}=90\%$		2.5		A
Low-Side Switch Current Limit	$I_{LS(OC)}$	$V_{IN}=12V, V_{FB}=90\%$		2		A
High-Side MOS ON-Resistance	$R_{DSON(HS)}$	$I_{sw}=100mA$		200		$m\Omega$
Low-Side MOS ON-Resistance	$R_{DSON(LS)}$	$I_{sw}=100mA$		120		$m\Omega$
EN Rising Threshold	$V_{EN(R)}$	$4.5V \leq V_{IN} \leq 30V$	1.5			V
EN Falling Threshold	$V_{EN(F)}$	$4.5V \leq V_{IN} \leq 30V$			0.4	V
EN Hysteresis	$V_{EN(HYS)}$			0.15		V
Soft Start	T_{SS}	$10\% * V_{out}$ to $90\% * V_{out}$		1		ms
Over-Temperature Protection	T_{SD}			160		$^{\circ}C$
Over-Temperature Protection hysteresis	ΔT_{SD}			30		$^{\circ}C$



TYPICAL CHARACTERISTICS

Test Condition: TA = 25°C, VIN=12V, Vout=5V, unless otherwise noted.

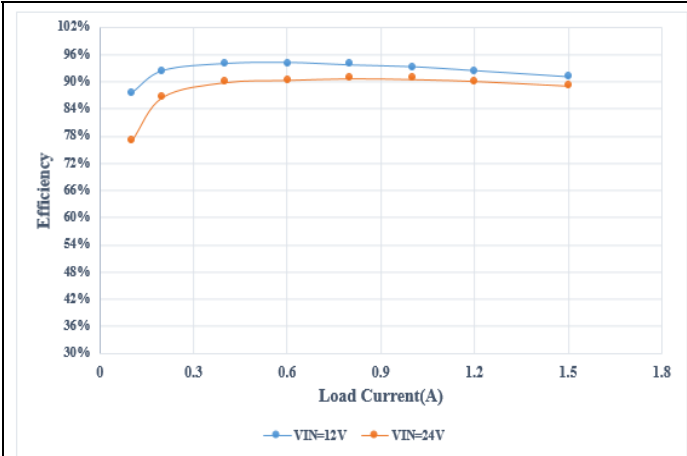

Figure1 5V Output Efficiency

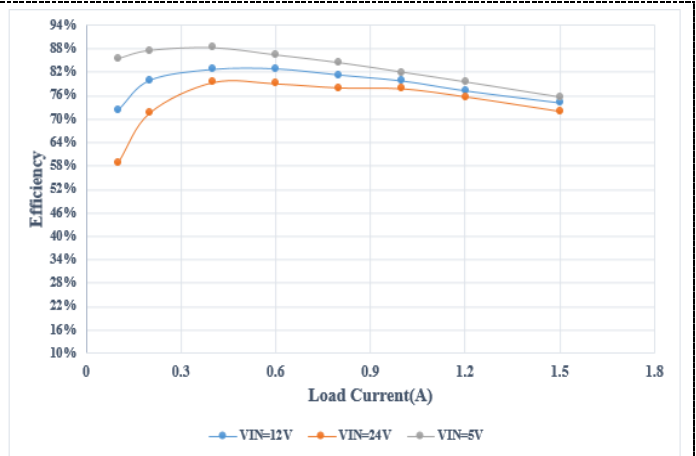

Figure2 1.2V Output Efficiency

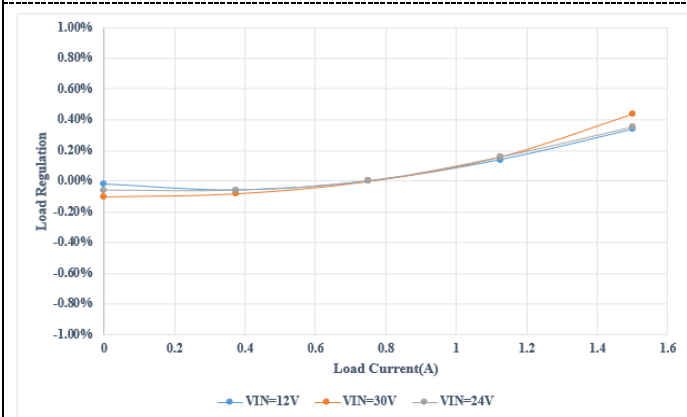

Figure3 5V Output Load Regulation

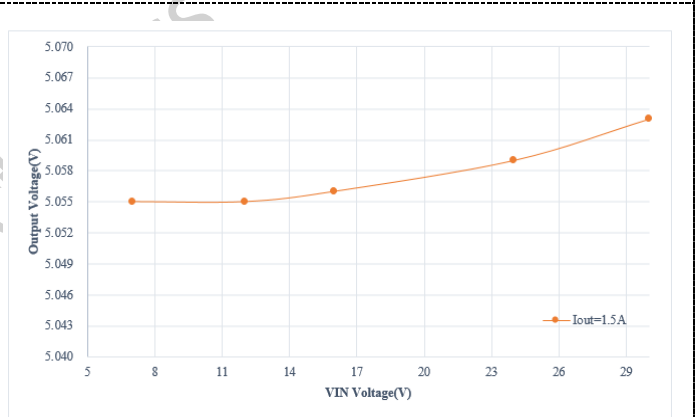

Figure4 Line Regulation Iout=1.5A

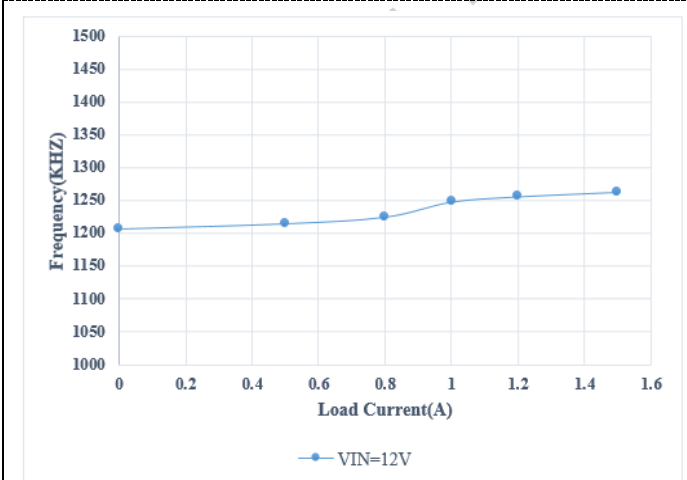

Figure5 Switch Frequency vs Load

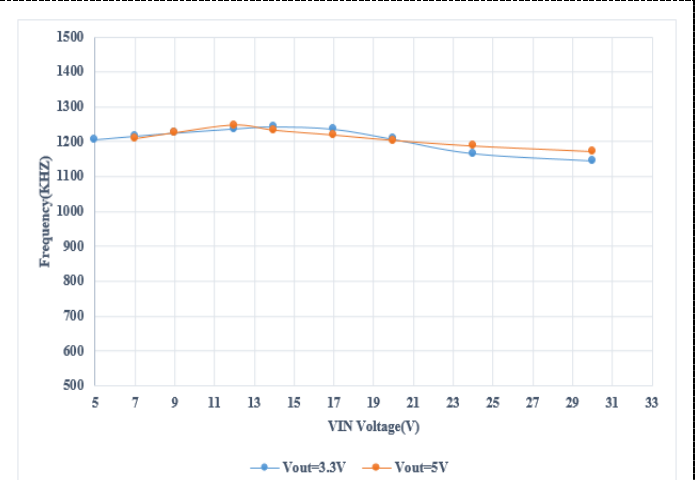
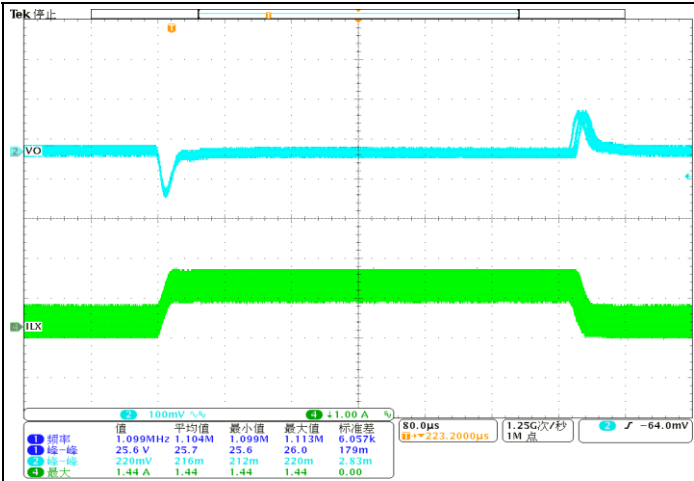
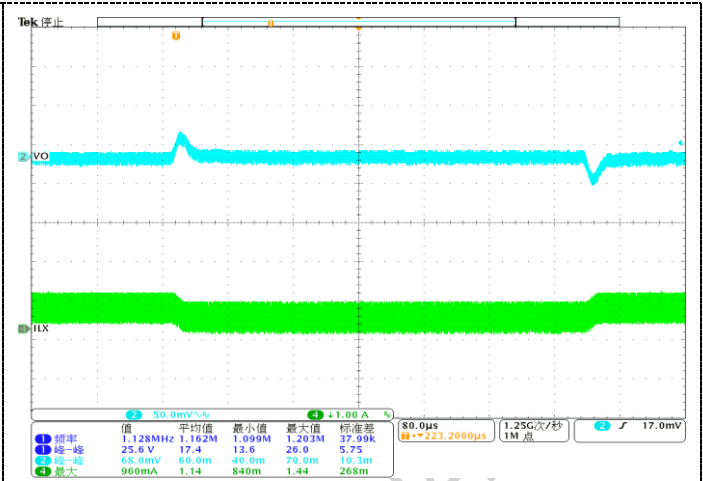

Figure6 Switch Frequency vs Load



Load Step 0.1 to 1.5A, 1A/us Slew rate

Figure7 Load Transient



Load Step 0.3 to 75A, 1A/us Slew rate

Figure8 Load Transient

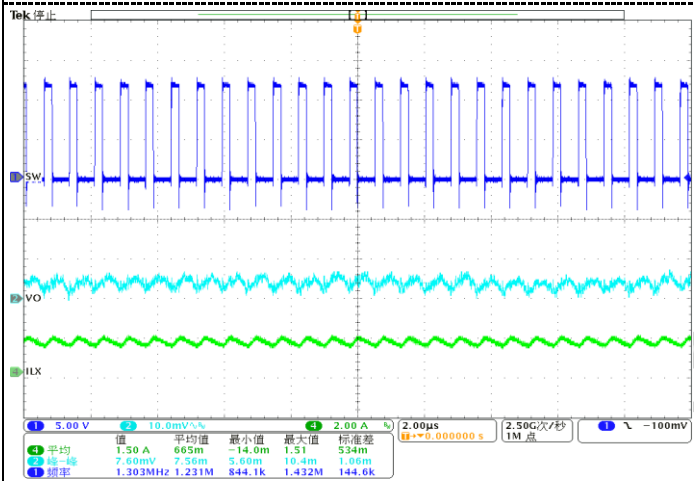

Iout=1.5A

Figure9 CCM Mode

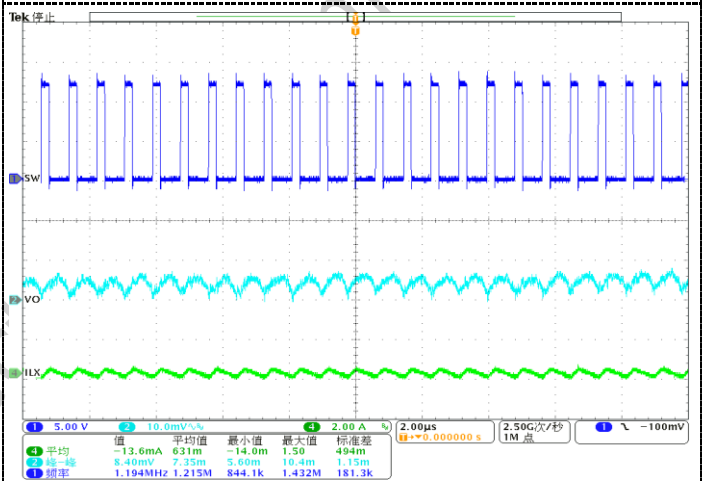

Iout=0 A

Figure10 CCM Mode

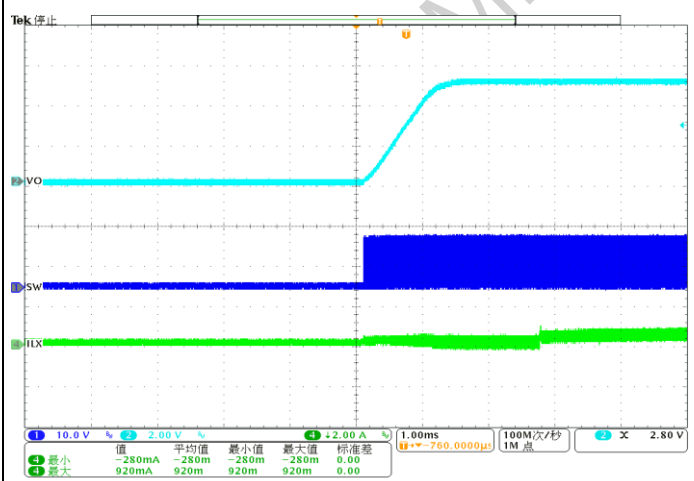

Iout=1.5A

Figure11 EN StartUp with Load

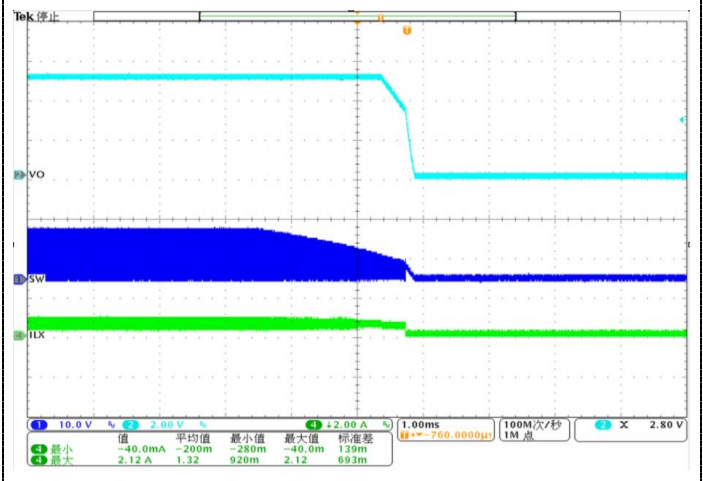

Iout=1.5A

Figure12 EN ShutDown with Load



FUNCTIONS DESCRIPTION

● Feature Description

The DP31231F is a COT mode step down DC/DC converter that provides excellent transient response with no extra external compensation components. This device contains an internal, low resistance, high voltage power MOSFET, and operates at a high 1.5MHz operating frequency to ensure a compact, high efficiency design with excellent DC performance.

● Thermal Shutdown

The internal thermal-shutdown circuitry forces the device to stop switching if the junction temperature exceeds 160 ° C typically. Once the junction temperature falls below the falling threshold, the device returns to normal operation automatically.

● Soft Start

The soft-start is implemented to prevent the converter output voltage from overshooting during startup. When the chip starts, the internal circuitry generates a soft-start voltage (SS) ramping up from 0V to 0.8V. When it is lower than the internal reference (REF), SS overrides REF so the error amplifier uses SS as the reference. When SS is higher than REF, REF regains control. The SS time is internally max to 1000us.

● Startup AND Shutdown

The If both VIN and EN are higher than their appropriate thresholds, the chip starts. The reference block starts first,generating stable reference voltage and currents, and then the internal regulator is enabled. The regulator provides stable supply for the remaining circuitries. Three events can shut down the chip: EN low, VIN low and thermal shutdown. In the shutdown procedure, the signaling path is first blocked to avoid any fault triggering.The comp voltage and the internal supply rail are then pulled down. The floating driver is not subject to this

shutdown command.

● UNDER-VOLTAGE LOCKOUT (UVLO)

Under-voltage lockout (UVLO) protects the chip from operating at an insufficient supply voltage. UVLO protection monitors the internal regulator voltage. When the voltage is lower than UVLO threshold voltage, the device is shut off. When the voltage is higher than UVLO threshold voltage, the device is enabled again.

● INPUT Over Voltage Protection(OVP)

The DP31231F Integrates input over voltage protection. The OVP circuitry detects over voltage condition by monitoring the input voltage. When input voltage rises above the OVP threshold , the OVP comparator turns high and both HS-FET and LS-FET are turned off. Once VIN drops below OVP falling threshold, the IC starts switching again. This function can ensure the reliability when the input voltage is unstable with over voltage spike.



APPLICATION INFORMATION

The output stage of synchronous buck converter is mainly composed of inductor and capacitors. By switching the internally integrated power MOSFET, the energy is stored and transferred to the load, and the second-order LC filter is formed to smooth the switching node voltage so that the stable output DC voltage is obtained.

● Setting Output Voltage

The output voltage is set by FB voltage, which is divided by resistor (R1 & R2) from output node to Ground. That resistor with 1% or higher accuracy is preferred. The output voltage value is set by equation as below.

$$V_{OUT} = V_{FB} \times ((R1 + R2) / R2)$$

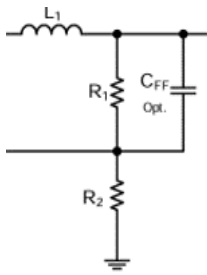

Vref is the internal reference voltage of DP31231F, 0.8V.

Table1 Recommend Component Selection Table

VOUT (V)	R1 (kΩ)	R2 (kΩ)	BS (uF)	L1 (uH)	CIN (uF)	COU (uF)	CFF(pF) Opt.
1.2	10	20	0.1	1R0~4R7	22	44	0~100
3.3	47	15	0.1	2R2~4R7	22	44	0~100
5.0	43	8.2	0.1	4R7	22	44	0~100
12	43	3	0.1	6.8~22	22	44	0~100

● Inductor selection

An inductor is required to supply constant current

to the load while being driven by the switched input voltage. The common value of the inductance is between 1uH to 22uH. A larger value inductor will result in less current ripple and lower output voltage ripple. However, the larger value inductor will have larger physical size, higher DC resistance, and/or lower saturation current. A good rule to calculate the inductance is to allow the peak-to-peak ripple current in the inductor to be approximately 30% of the maximum load current. At the same time, it is needed to make sure that the peak inductor current is below the inductor saturation current.

The inductance value can be calculated by:

$$L = \frac{V_{OUT}}{f_s \times \Delta I_L} \left(1 - \frac{V_{OUT}}{V_{IN}} \right)$$

Where VOUT is the output voltage, VIN is the input voltage, fs is the switching frequency, and ΔL is the peak-to-peak inductor ripple current.

The maximum inductor peak current is:

$$I_{L(MAX)} = I_{LOAD} + \frac{\Delta I_L}{2}$$

The choice of which style inductor to use mainly depends on the price vs. size requirements and any EMI constraints.

Under light load conditions below 100mA, larger inductance is recommended for improved efficiency

● Input capacitors selection

The input current to the step-down converter is discontinuous, therefore a capacitor is required to supply the AC current to the converter. It is recommend to use low ESR capacitors to optimize the performance. Ceramic capacitor is preferred, but tantalum or low-ESR electrolytic capacitors may also meet the requirements. It is better to choose X5R or X7R dielectrics when using ceramic capacitors.

Since the input capacitor (CIN) absorbs the input switching current, a good ripple current rating is required for the capacitor. The RMS current in the input capacitor can be estimated by:



$$I_{CIN} = I_{load} \times \sqrt{\frac{V_{OUT}}{V_{IN}} \times \left(1 - \frac{V_{OUT}}{V_{IN}}\right)}$$

The worst-case condition occurs at $V_{IN} = 2 \times V_{OUT}$, where:

$$I_{CIN} = \frac{I_{load}}{2}$$

For simplification, choose the input capacitor whose RMS current rating is greater than half of the maximum load current. When electrolytic or tantalum capacitors are used, a small, high quality ceramic capacitor, i.e. 0.1μF, should be placed as close to the IC as possible. When ceramic capacitors are used, make sure that they have enough capacitance to maintain voltage ripple at input. The input voltage ripple caused by capacitance can be estimated by:

$$\Delta V_{IN} = \frac{I_{load}}{f_s \times C_{IN}} \times \frac{V_{OUT}}{V_{IN}} \times \left(1 - \frac{V_{OUT}}{V_{IN}}\right)$$

C_{IN} is the input capacitance.

● Output capacitors selection

The output capacitor (C_{OUT}) is required to maintain the DC output voltage. Ceramic, tantalum, or low ESR electrolytic capacitors are recommended. Low ESR capacitors are preferred to keep the output voltage ripple low. The output voltage ripple can be estimated by:

$$\Delta V_{OUT} = \frac{V_{OUT}}{f_s \times L} \times \left(1 - \frac{V_{OUT}}{V_{IN}}\right) \times \left(R_{ESR} + \frac{1}{8 \times f_s \times C_{OUT}}\right)$$

Where L is the inductor value, R_{ESR} is the equivalent series resistance (ESR) value of the output capacitor and C_{OUT} is the output capacitance value. In the case of ceramic capacitors, the impedance at the switching frequency is dominated by the capacitance. The output voltage ripple is mainly determined by the capacitance. For simplification, the output voltage ripple can be estimated by:

$$\Delta V_{OUT} = \frac{V_{OUT}}{8 \times f_s^2 \times L \times C_{OUT}} \times \left(1 - \frac{V_{OUT}}{V_{IN}}\right)$$

In the case of tantalum or electrolytic capacitors, the ESR dominates the impedance at the switching frequency. For simplification, the output ripple can be approximated to:

$$\Delta V_{OUT} = \frac{V_{OUT}}{f_s \times L} \times \left(1 - \frac{V_{OUT}}{V_{IN}}\right) \times R_{ESR}$$

The characteristics of the output capacitor also affect the stability of the regulation system. The DP31231F can be optimized for a wide range of capacitance and ESR values.

● Feed-Forward Capacitor Selector(CFF)

DP31231F has internal loop compensation, so adding CFF is optional. Specifically, consider whether to add feed-forward capacitors according to the situation.

The use of a feed-forward capacitor (CFF) in the feedback network is to improve the transient response or higher phase margin. To reduce transient ripple, the feed-forward capacitor value can be increased to push the cross frequency to higher region. Although this can improve transient response, it also decreases phase margin and cause more ringing. In the other hand, if more phase margin is desired, the feed-forward capacitor value can be decreased to push the cross frequency to lower region.

the value of feed-forward capacitor (CFF) can be calculated with the following equation:

$$C_{ff_op} = \frac{1}{2\pi \times f_{_nocff}} \times \sqrt{\frac{1}{R_1} \times \left(\frac{1}{R_1} + \frac{1}{R_2}\right)}$$

Where $f_{_nocff}$ is the cross frequency. the crossing frequency is generally taken as 1/10 to 1/5 of the switching frequency, R_1 and R_2 are feedback resistors.

● Bootstrap Capacitor Selection



Bootstrap Capacitor Selection A 0.1- μ F ceramic capacitor must be connected between the VBST to SW pin for proper operation. recommends to use a ceramic capacitor.

● PCB Layout

PCB layout is a critical portion of good power supply design. The following guidelines will help users design a PCB with the best power conversion efficiency, thermal performance, and minimized EMI.

1. The feedback network, resistor R1 and R2, should be kept close to FB pin. Vout sense path should stay away from noisy nodes, such as SW & BS signals and preferably through a layer on the other side of shielding layer.
2. The input bypass capacitor C5 and C2 must be placed as close as possible to the VIN pin and ground. Grounding for both the input and output

capacitors should consist of localized top side planes that connect to the GND pin and PAD. It is a good practice to place a ceramic cap near the VIN pin to reduce the high frequency injection current.

3. The inductor L should be placed close to the SW pin to reduce magnetic and electrostatic noise.
4. The output capacitor, COUT should be placed close to the junction of L1. The L1, and COUT trace should be as short as possible to reduce conducted and radiated noise and increase overall efficiency.
5. The ground connection for C5, C2 and C8, C4 ,C3 should be as small as possible and connect to system ground plane at only one spot (preferably at the COUT ground point) to minimize injecting noise into system ground plane.
6. Large GND Copper Pour near IC is recommended to minimize the heat of IC.

● Layout Example:

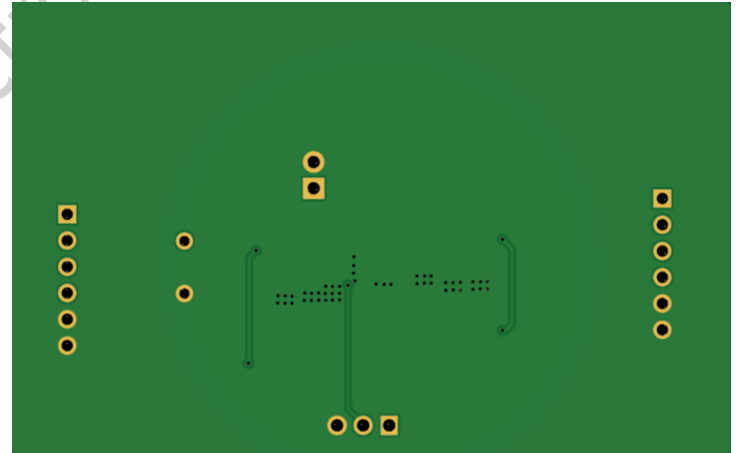
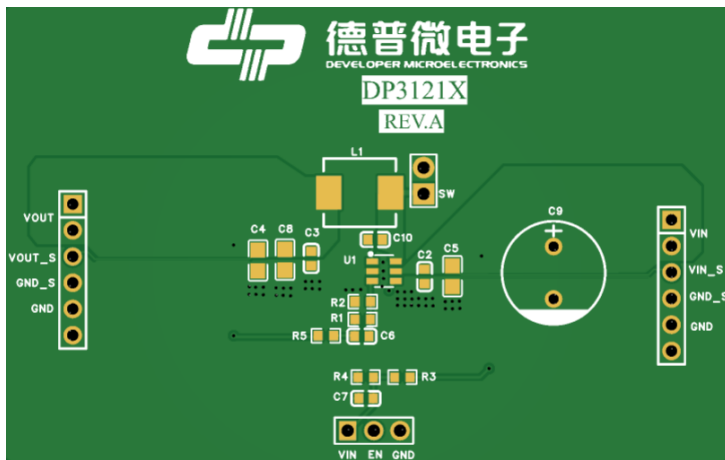



PACKAGE DIMENSION

SOT23-6

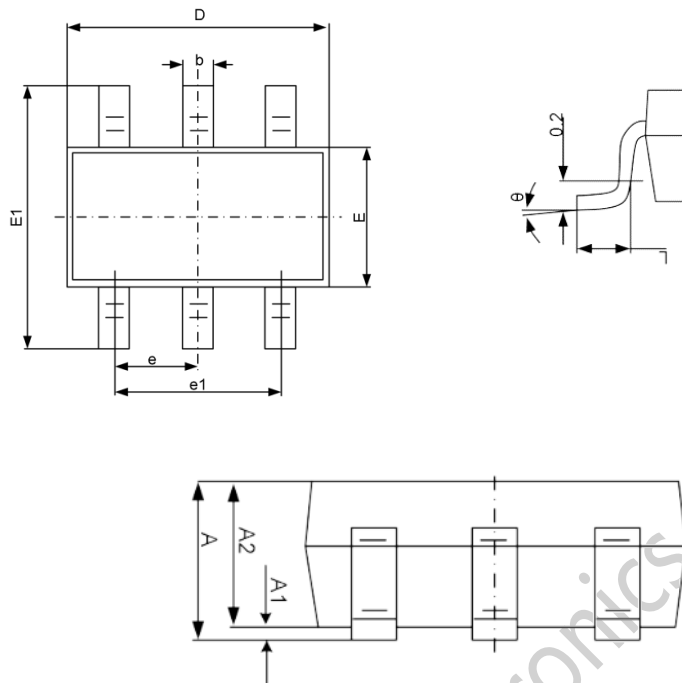

Symbol	Dimensions in Millimeters	
	Min	Max
A	-	1.350
A1	0.000	0.150
A2	1.000	1.200
b	0.300	0.500
c	0.100	0.220
D	2.820	3.020
E	1.500	1.700
E1	2.600	3.000
e	0.950(BSC)	
e1	1.800	2.000
L	0.300	0.600
θ	0°	8°



REVISION HISTORY

Editions	Revised Date	Redaction person	Revision content
A.0	2023/12/23	PXB	First release

Developer Microelectronics Confidential



OFFICIAL ANNOUNCEMENT

Division I will ensure the accuracy and reliability of the product specification document, but we reserve the right to independently modify the content of the specification document without prior notice to the customer. Before placing an order, customers should contact us to obtain the latest relevant information and verify that this information is complete and up-to-date. All product sales are subject to the sales terms and conditions provided by our company at the time of order confirmation.

Division I will periodically update the content of this document. Actual product parameters may vary due to differences in models or other factors. This document does not serve as any express or implied guarantee or authorization.

The product specification does not include any authorization for the intellectual property owned by our company or any third party. With respect to the information contained in this product specification, we make no explicit or implied warranties, including but not limited to the accuracy of the specification, its fitness for commercial use, suitability for specific purposes, or non-infringement of our company's or any third party's intellectual property. We also do not assume any responsibility for any incidental or consequential losses related to this specification document and its use.

We do not assume any obligations regarding application assistance or customer product design. Customers are responsible for their own use of our company's products and applications. In order to minimize risks associated with customer products and applications, customers should provide thorough design and operational safety validation.

The reproduction, transmission or use of this document or its contents is not permitted without express written authority. Once discovered, the company will pursue its legal responsibility according to law and compensate for all losses caused to the company.

Please note that the product is used within the conditions described in this document, paying particular attention to the absolute maximum rating, operating voltage range, and electrical characteristics. The Company shall not be liable for any damage caused by malfunctions, accidents, etc. caused by the use of the product outside the conditions stated in this document.

Division I has been committed to improving the quality and reliability of products, but all semiconductor products have a certain probability of failure, which may lead to some personal accidents, fire accidents, etc. When designing products, pay full attention to redundancy design and adopt safety indicators, so as to avoid accidents.

When using our chips to produce products, Division I shall not be liable for any patent dispute arising from the use of the chip in the product, the specification of the product, or the country of import, etc., in the event of a patent dispute over the products including the chip.